

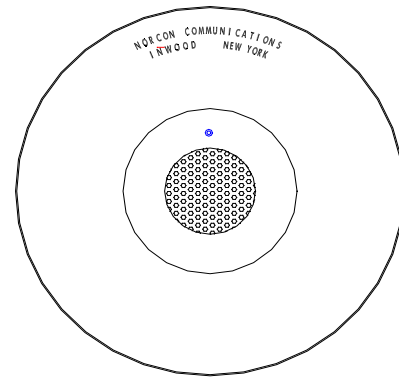

**Norcon TTU@ -1X Series**  
Installation & Operating  
Instructions



- Introduction .....1
- Features .....1
- How It Works .....2
- How To Install .....3-4
- How To Use The Talk-Thru Communicator ..... 5
- Operation Hints ..... 6
- Specifications ..... 7
- Accessories and Options ..... 8
- TTU@ -1X Series ..... 9
- Norcon TTU@-7X Series .....11
- Norcon TTU@-3X Series..... 12
- Troubleshooting .....13
- Warranty .....14

## TTU@ -1X Series 2-Way Talk-Thru Electronic Communication System.

A voice communications system for High-Security and Isolation Booth Situations. In today's security conscious environment, isolation booths are often the ideal recourse to protect your employees. But does it facilitate and help maintain your very important public image? Not if clerks and customers have to yell and repeat themselves to be heard or understood.

**Norcon's Patented TTU@ -1X Talk-Thru Communicator** is a 2-way, hands-free audio system that provides high-quality personal communication between people separated by security or isolation barriers. It is the most widely used system of its type in the U.S., and the world.

### FEATURES

- Clear 2-way hands-free voice communication.
- Quality electronic design and engineering.
- Avoid raising your voice, repetition & misunderstanding.
- XLR removable mic for your convenience.
- Simple, one-person installation.
- Rugged, tamper-resistant materials. Anodized aluminum
- Self-powered with fast rechargeable battery option.
- Bullet-resistant option (UL level 3).
- Units available for ADA applications.
- Headset jack equipped on all models. Headset can be ordered separately.
- Export models available

### HOW IT WORKS ...

The Norcon TTU@ system permits hands-free, 2-way communication between the booth attendant and the customer. Unique circuitry facilitates ongoing, clear, 2-way conversation at all times – as if the two parties were together in the same room. The TTU@-1X Talk-Thru Communicator now incorporates circuitry to automatically attenuate the outside channel. If the gooseneck microphone is not used for a period of 30 seconds, the outside channel volume will be reduced approximately 70%. Normal operation is restored as soon as the attendant speaks into the gooseneck microphone. The automatic volume attenuation circuit prevents outside noise from bothering the attendant.

The TTU@ -1X provides clear communication even in environments with high ambient noise by shaping the sound for maximum intelligibility. Its compression circuitry decreases loud, annoying sounds.

### HOW TO INSTALL ...

Installation of the TTU@ -1X is a very simple, one-person operation. All that's needed is a 3" to 4" diameter cutout in the barrier. Four fasteners and two rubber gaskets for mounting are supplied. The front face and housing are easily mounted on opposite sides of the barrier using the fasteners. The rubber gaskets prevent slippage and protects the barrier surface. The electronic section is then inserted into the housing and fastened in place.

### Installation Instructions:

Remove the four (4) 6-32 assembly screws. Separate the housing and electronics assembly. Unplug electronic assembly from the faceplate and housing. Set the electronic assembly aside, carefully. Remove the four (4) 8-32 mounting nuts from the mounting rods. Separate the faceplate and housing. Discard the shipping spacers located between the faceplate and housing if there are any. Hold the faceplate over the partition opening. Carefully center the faceplate and align the lettering horizontally. Masking tape can be used to temporarily hold the faceplate to the outside of the partition.

On the inside of the partition mount the housing over the four (4) 8-32 mounting rods. Be certain to position the housing so that the threaded hole is positioned properly. If using tubing, orient the hole in the direction which the tubing is to exit (left, right, top, and bottom). If tubing is not being used, place the plugged hole at the bottom.

#### Recommended cables for wiring:

For power connections use **West Penn wire #221**. This is a stranded single pair 22 awg, Plenecon -II jacket Rohs cable. Keep Mic/spk and power cable bundles away from other power cable. For power connection, route the one pair cable (with the connector on one end). From the inside unit to the location of the PS-1 power supply. Connect the conductors to the power supply (RED to +ve, BLACK to -ve). Plug the connector to its mate from the printed circuit board. Connect 4 – pin polarized connectors and reassemble units

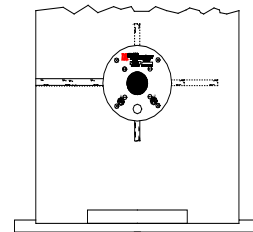
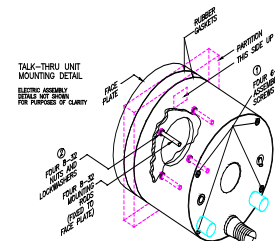

Place the housing so that the threaded hole can be positioned properly. If using tubing, orient the hole in the direction in which the tubing is to exit as shown in the drawing.

Be certain to position the housing so that the threaded hole can be positioned properly. If using tubing, orient the hole in the direction which tubing is to exit.

### HOW TO USE THE TALK-THRU COMMUNICATOR...

1. With power switch off, turn Talk and Listen controls completely counter clockwise.
2. Turn on the unit by switching the Power ON/OFF switch to its upper position. At this position, the unit is at the auto mute mode.
3. Adjust the TALK volume control until the attendant is clearly heard by the person outside the window when the attendant is speaking 2" to 4" from the gooseneck microphone at a normal speaking level. The green LED should go on when the attendant starts talking and go off when the attendant stops talking. **If the green LED stays lit constantly, it indicates either the TALK volume setting or the ambient noise is too high.**
4. Adjust the LISTEN control until the person outside the window is clearly heard when speaking at a normal level.

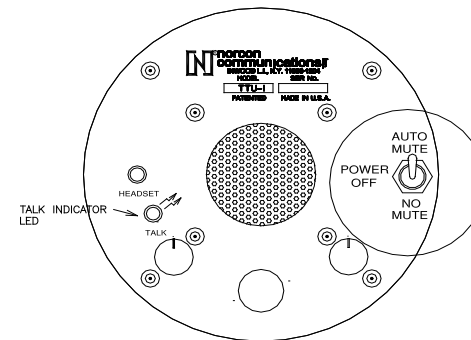

### OPERATION HINTS:

1. Increasing the talk volume control allows the attendant to speak further away from the microphone as well as increasing the talk channel volume. The optimum distance from the microphone should be maintained at approximately 2"-4" or conversations not directed to customers may be heard outside the booth. Watch the green LED above the TALK volume control, it should be ON only when talking into the gooseneck microphone and off when not talking to the microphone.
2. Installing a headset into the Headset jack will allow communications from the headset and disconnect the speaker and the gooseneck microphone.
3. The unit will decrease the incoming volume level by approximately 70% some 30 seconds after the attendant stops speaking into the microphone. The purpose of this feature is to decrease the amount of extraneous noise entering the booth. Normal volume level is restored when the attendant speaks into the microphone. The muting function can be defeated by switching the POWER SWITCH to the NO MUTE position.



### SPECIFICATIONS:

#### MECHANICAL:

- Outside faceplate: Aluminum, anodized finish, tamper-resistant.
- Control housing (inside): Machined aluminum, anodized finish, tamper-resistant.
- Size: Outside faceplate 5" Dia. x 1/2" D. Inside control housing: 5" Dia. x 2-1/2" D (TTU@-1 AX) (TTU@-1 AX) 5" Dia. x 3-1/2" D (TTU@-1 D X) (TTU@-1 ABX)
- Weight: ~ 5 LB.
- Mounting: **Partition hole 3 to 4" Dia. (3-1/2" recommended) Specify barrier thickness when ordering. Norcon will adjust the length of the mounting rods to meet your need.** Panel Controls: LISTEN volume, TALK volume, POWER On/Off, AUTO MUTE On/Off.

#### ELECTRONIC:

- Audio frequency response: Selectively shaped for maximum voice intelligibility.
  - Audio power: 2 watts per amplifier.
  - Distortion: Less than 2%.
  - Listen mode: 20dB compression.
  - Microphone: Electret.
  - Power Supply Adapter: Input 90-240V AC, 60 Hz. Output 15V DC, 1A. UL, (Canada and US) CE, level VI.
- Specifications are subject to change without notice.

## TROUBLESHOOTING:

You may occasionally encounter a problem with your TTU® system. If this happens, refer to the trouble shooting list. If additional help is needed, please contact us.

### No sound at all

- **Is the power cable properly connected to power supply and the power supply plugged into a working outlet?**

The power cable red wire should be connected to (+) and black wire connected to (-) the power supply. The power supply should have been plugged into a working outlet.

### Howling ( Feedback)

- **Is the TALK or LISTEN volume turned too high?**

Set the volume control to a proper level. In most cases, both TALK and LISTEN controls should be set to the position of around 11 to 12 o'clock.

### Conversation cutting-off and breaking-up

- **Is the TALK volume setting too high?**

Turn down TALK volume to a proper level. Make sure the green LED is off when not talking to the gooseneck microphone.

- **Is the attendant talking too far from the gooseneck microphone?**

The ideal distance is 3" to 4" from the gooseneck microphone.

### TTU®-1 DX does not work when operated by internal battery.

- **Are the batteries fully charged?**

If the unit is newly installed, allow the batteries to be charged for 10-12 Hrs. before operating. The unit can be used while the batteries are being charged.

- **Is the battery charger plugged into a working outlet?**

If the battery charger is plugged into a working outlet, and the batteries are being charged, the battery charger should be warm, if it is not; the battery charger may be defective.

7

## Introducing the Norcon TTU® -1 NCX:

When using a Talk-thru unit in a noisy area such as heavy traffic street, a crowded movie theater hall way or a gas station, the noise makes the conversation difficult. A powerful DSP inside the Norcon noise cancellation unit samples an ambient noise environment and attenuates the noise around the desired speech signals. As a result, continuous and repetitive noise is removed; a clear conversation will be even with a passing truck in the background.

To take the advantage of this new technology, the existing unit can be sent to us for upgrade.

### Accessories for TTU®:

**ANC 700 Headset (Optional)** for use with regular non RF ready units **TTU-NCHS:**

- Superior sound quality
- Noise Cancellation microphone
- Long wearing comfort



11

## TTU®-1X Series:

Select from available models with detachable XLR mic.

- TTU® -1AX continuous power unit. Housing 5" Dia x 2 ½" depth.
- TTU® -1AWX Wireless ready.
- TTU®-1ABX same as TTU®-1AX, but with bullet-resistant option (UL Level 3).
- TTU®-1ACX same as TTU®-1AX without gooseneck microphone for headset use only.
- TTU®-1DX Battery operated unit. Complete with rechargeable batteries and charger. Housing 5" Dia x 3 ½" depth.
- TTU®-1DBX same as TTU®-1DX, but with bullet-resistant option (UL Level 3).

Talk-Thru systems are shipped complete with cables, instructions, and power supply.

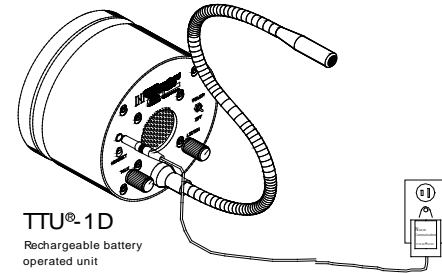

TTU-1DX ( battery version)

8

## Professional Wireless Headset System (Optional) for use with regular non RF ready units TTU-WHS:

- **Mobile:** DETC 6.0 technology hand-free mobile design with range of up to 300 feet from base unit
- **Duo-Set Headset:** Adjustable for over-the-head stability or over-the-ear convenience with new conformable ear loop
- **Extended Use:** Ten hours continuous talk time on rechargeable battery.



### Headset (Optional for use with wireless ready TTU-1X, TTU-3X & TTU-7X Series).

- TTU-WHS-D wireless headset transceiver
- Norcon TTU-NC181 Headset
- USB Charger & Micro USB cable

12

## Introducing the Norcon TTU® -3X Series:

There are times, when it is inconvenient to cut a 3" to 4" hole through an isolation barrier; the Norcon TTU®-3X is the solution for this situation.

The TTU®-3X is a pair of 6" or 12" prism-shaped units for mounting on a counter top on both sides of a barrier. They allow hands free communication through barriers typically found in banks, cashier's booths, information booths, and similar environments.

Norcon provides audio/visual, communications, and secure talk-thru solutions for critical applications around the world. TTU-3X with removable mic for your convenience.

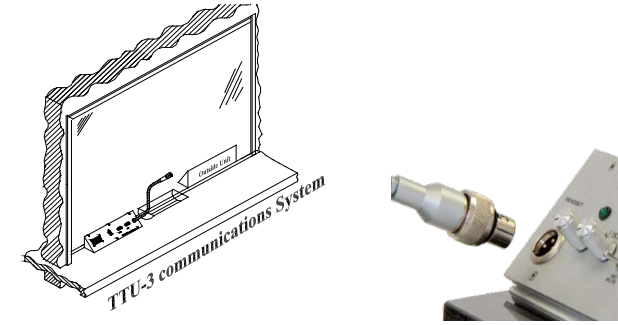

9

## Professional Wireless Headset System (Optional) TTU® -WHS-D:

Wireless Headset is designed to work with the TTU-WR Wireless ready unit only.

### FEATURES

- Clear 2-way hands-free voice communication.
- Quality engineering and innovative design
- Walk around freely while talking to the customer.
- Self-powered unit with rapid rechargeable battery



## Microphone Grill Windscreen Sponge

### Specification:

- Material: Foam ,Color: Black
- I D: Approx. 12mm, Size: Approx. 65x10mm (L\*W)
- High elasticity, durable and soft, Replacement for your worn-out or lost headset microphone pads

### Package include:

5 pcs of Microphone Windscreen



13

## Introducing the Norcon TTU®-7X:

**Special design for the window with a secure pull-down gate or shade.**

In some cases, when it's impractical to mount the inside control section of the TTU®-3X in a window with secure gate or shade the TTU®-7X is your choice. The TTU®-7X incorporates the same high-quality electronics as the basic TTU®-3X, but with a 1" low profile window mount section, and a prism shaped counter mounting control section.

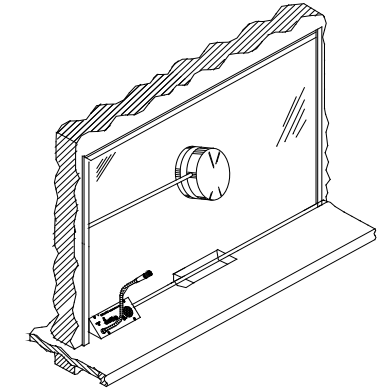

10

## Service Policy

### TALK-THRU SYSTEM WARRANTY REPAIRS

Norcon Communications Inc. warrants the products Manufactured by Norcon to be free from defects in material and workmanship for a period of **one year** \* from the date of shipment from the factory provided:

- 1) The product has not been abused, misused or improperly maintained, repaired and /or modified during such period, and
- 2) Such defect is not a result of voltage surges/ burnouts, lightning, water damage / flooding, fire, explosion, earthquakes, tornadoes, acts of aggressions /war or similar phenomenon; and
- 3) The product has been properly installed according to the appropriate Norcon Installation Guide.

Both incoming and outgoing freight charges are at customer's expenses. Domestic repair will be returned to customer by UPS Ground. International repair will be returned to customer using normal shipping arrangements. Any other shipping instructions must be made in writing and will be at the customer's expense.

\* **Extended two years warranty available on request**

14